

MODEL	VOLTAGE TYPE	HZ	WATTS	ION COUNT	MAX CFM	*COVERAGE AREA
BPI GEN	24VDC or 115V	50/60	7W	49.8M / cm3	1,800	2,000 ft ²

*Coverage area depends on airflow sent through BPI device.

Description

The Air-Row BPI uses bi-polar ionization technology, which is a type of air purification that uses voltage to generate electrically charged particles with extra electrons. The BPI is a needle point bi-polar ionization cartridge that creates positively and negatively charged ions, that help purify indoor air quality for human occupancy. The BPI cartridge carries two precise carbon fiber emitters to create electrodes which helps break down molecule chains into smaller and less harmful substances in bacteria and viruses.

BPI with Destratification

Our specific BPI cartridge can be installed in all Air-Row Fan applications. With in-house testing and precise placement, the BPI helps neutralize viruses and bacteria while the fan sends the purified air towards the ground helping with poor air circulation which converts to cleaner air and significant energy savings.

Specifications

- 24VDC option for HVAC connection without fan
- 115V power option when BPI is mounted in fan
- Inline C-Class Fusing: 100mA @ 115V
- 300V (24 AWG) power wire
- RED wire – Positive / Black wire – Neutral
- Ion Count = 49.8M / cm³
- Green LED will illuminate when powered & operating
- BPI unit can be powered 24/7 with fan







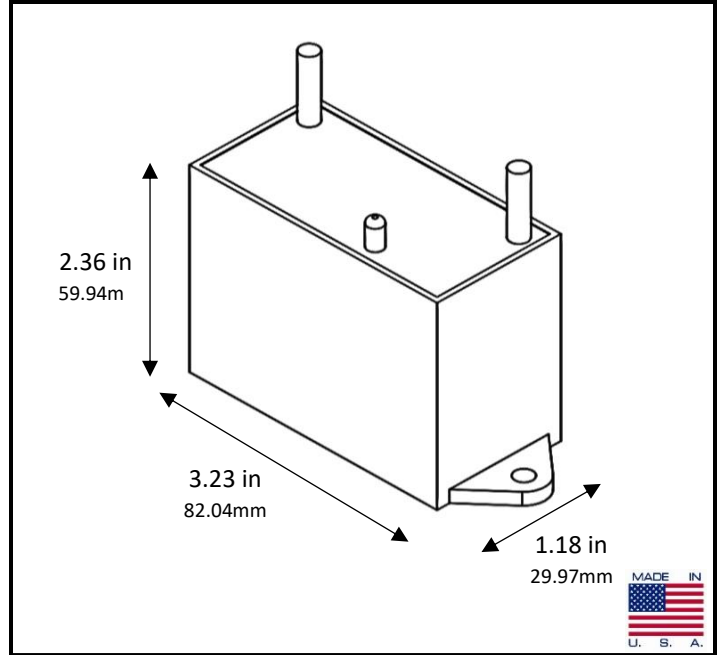

Certifications

- Conforms to UL STD 867. UL STD 2998
- Certified to: CAN/CSA STD C22.2 NO. 187

Warranty

- 2-year limited warranty included from date of purchase



	Norovirus -- 93.5% after 30 minutes of activation
	Human Coronavirus 229E -- 90% after 60 minutes of activation
	Legionella -- 99.7% after 30 minutes of activation
	Clostridium Difficile -- 86.8% after 30 minutes of activation
	Tuberculosis -- 69% after 60 minutes of activation
	MRSA -- 96.2% after 30 minutes if activation
	Staphylococcus – 96% after 15 minutes activation
	E. coli -- 96.2% after 30 minutes of activation
	Airborne Mold -- 99.5% , per tests by the Indoor Environment Tests Organization

Tests were conducted by EMSL Analytical, a platinum-rated lab by The Center for Disease Control.